

# Generating Advanced Radar Signals Using Arbitrary Waveform Generators

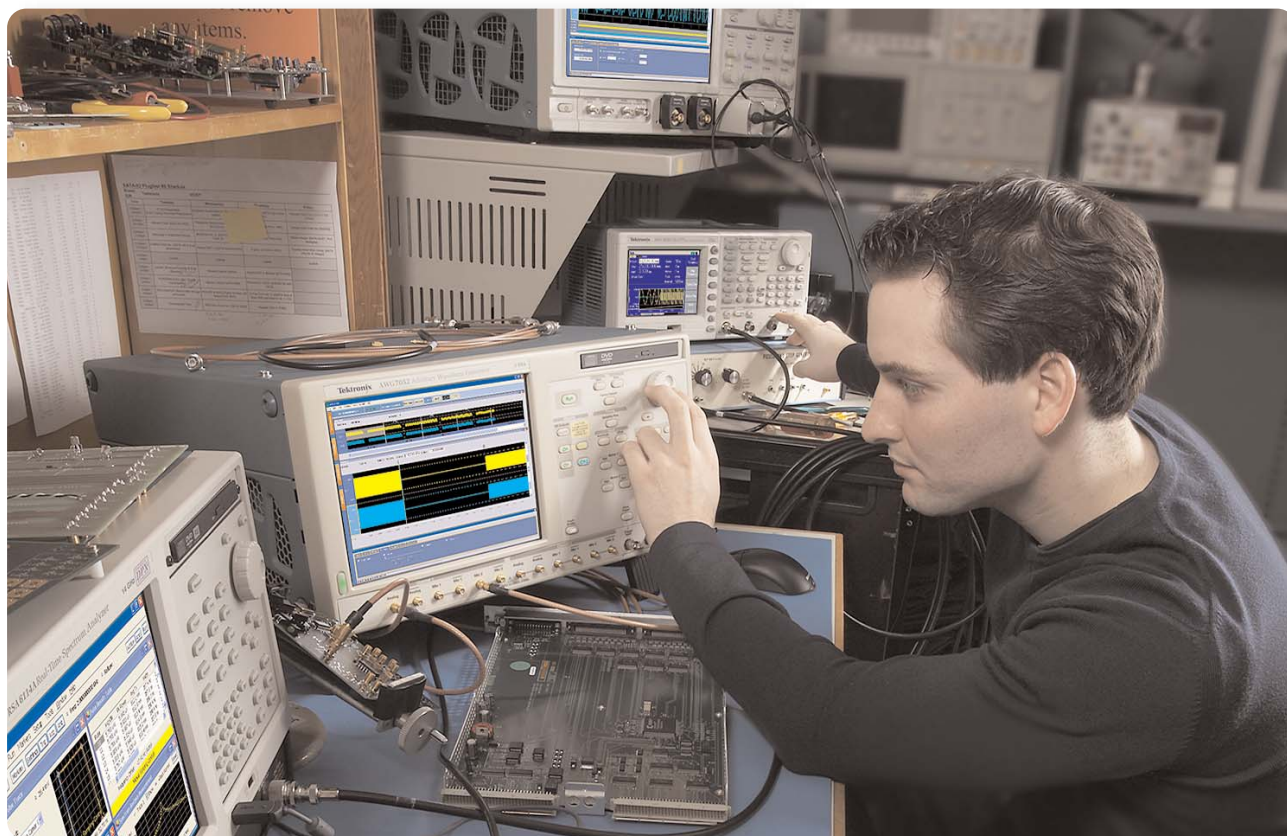

## Introduction

Radar signal generation and processing techniques are growing ever more advanced. These advances are being driven by the need to improve resolution (the ability to detect targets that are very close together) and reduce radar spectrum occupancy. Reducing spectral occupancy can serve two goals: reduce interference and minimize the probability of intercept (POI). These advanced designs are being implemented as digital radar where the data converters are very

close to the antenna and parameters such as demodulation, matched filtering, range gating, etc. are performed using digital signal processing (DSP). Field Programmable Gate Arrays (FPGAs) are emerging as a useful approach to digitally implemented radar systems due to flexibility and cost reduction. The use of FPGAs and DSP means that the effectiveness of the radar system is becoming increasingly dependent on the pre-distortion, filtering and detection algorithms.

# Generating Advanced Radar Signals Using Arbitrary Waveform Generators

► Application Note

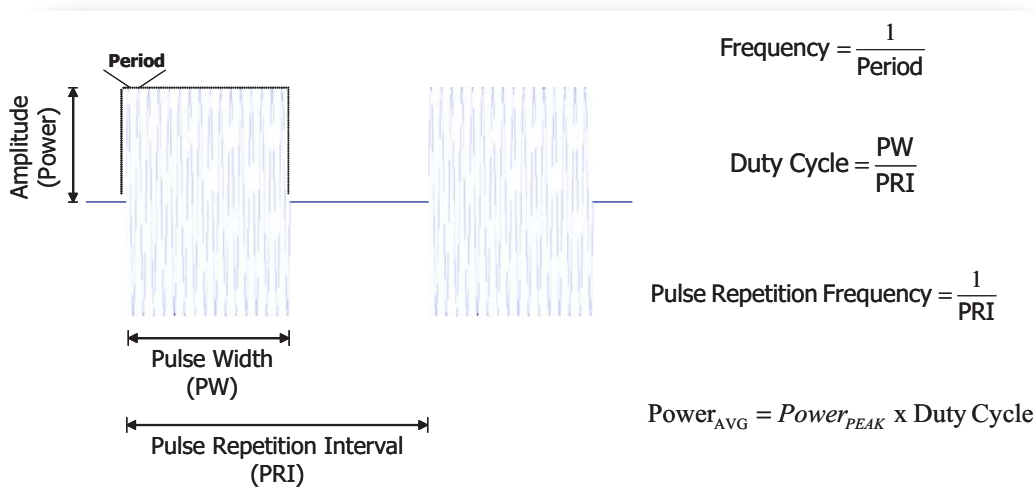

► **Figure 1.** Basic pulsed radar parameters.

This application note will provide a summarized review of radar essentials and some of the challenges in modern radar systems. This is followed by an explanation of how to take advantage of the increased sample rate, analog bandwidth, memory, and digital outputs found in the Arbitrary Waveform Generators (AWGs) in order to: increase resolution, decrease false target returns, and increase the probability of detecting actual targets. The last section will cover troubleshooting the radar transceiver chain.

## Radar Range and Resolution - the Fundamental Challenge

As with most transceiver design, radar is all about trade-offs; the transceiver typically gives up effectiveness in one parameter (for example resolution) in order to achieve better performance in another parameter (for example. range). Let's begin by discussing some fundamentals of radar range and resolution. Figure 1 includes the basic concepts and terms used in this section.

The first concept to understand is the range equation which tells us how much power that has been reflected from the target will be present at the radar receiver. The radar range equation and its defined variables are shown in the equation below.

$$P_r = \frac{P_t G_t A_r \sigma}{(4\pi)^2 R^4}$$

$P_r$  = power at Rx  
 $P_t$  = average Tx power  
 $G_t$  = gain of Tx antenna  
 $A_r$  = area of Rx antenna  
 $\sigma$  = target scattering coefficient  
 $R$  = target distance

**Equation 1.** The Radar Range Equation.

If it is desired to have increased range by increasing the reflected power from the target, why not simply increase the average transmitted power ( $P_t$  in the numerator of the range equation) in order to increase  $P_r$ ? The answer lies in the fact that it is average power, meaning power integrated over time, which includes the time when no signal is being transmitted. So, as we recall from Figure 1, in order to increase average power, we need to increase the peak power or the duty cycle.

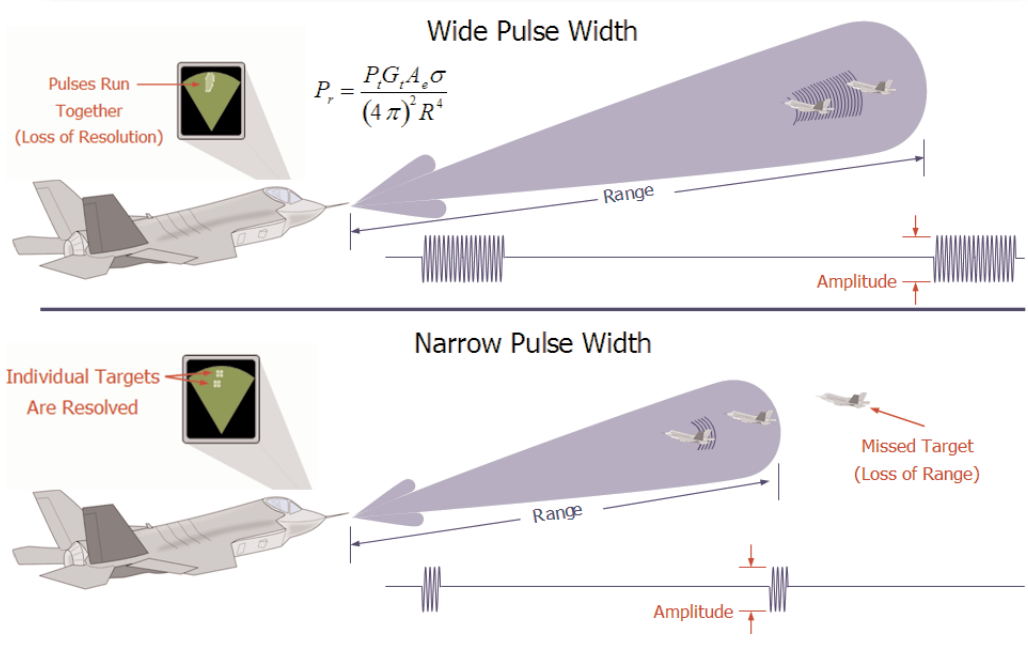

► **Figure 2.** Range versus resolution.

Increasing the peak power increases the complexity and cost of hardware such as klystron amplifiers, and all associated hardware in the transceiver chain has to be able to handle the larger peak power output. The other way to increase the average power is to increase the average “on time” of the RF burst, i.e. increase the duty cycle. While some radar systems are designed to “jitter” or vary the PRI over time, the most desirable method of increasing the duty cycle is to increase the pulse width. This is primarily due to the strain put on the transceiver by rapidly switching on and off the RF burst when increasing the PRI.

One significant disadvantage of increasing the pulse width is that resolution suffers. For a radar with an unmodulated pulse to resolve two targets in range, their range separation must be such that the trailing edge of the transmitted pulse will have passed the near target before the leading edge of the echo from the far target reaches the near target. This is illustrated in the Figure 2. As seen here, when the pulse is transmitted for a longer period of time, targets which are close together will both be the same pulse. This means that the return pulse (echo) from these returns will be overlapped, making it difficult to distinguish one from the other. Using a narrower pulse width, as seen in the bottom half of Figure 2, allows for the illumination of only one target at a time; however, the more distant target is missed.

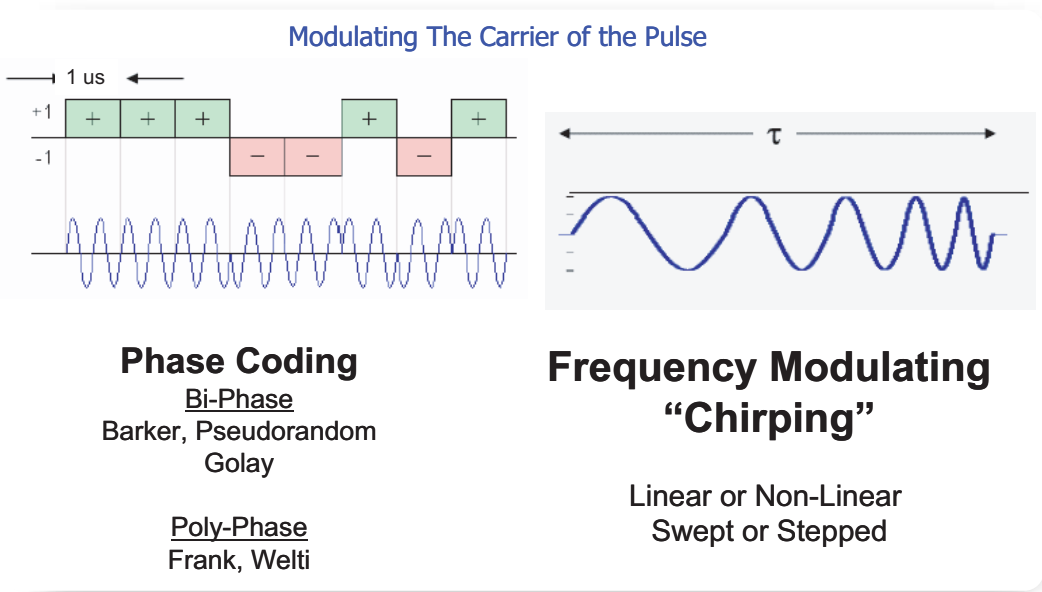

► **Figure 3.** Methods of creating a pulse compression waveform.

## Pulse Compression – the Solution to the Fundamental Challenge

So far we have seen there is a fundamental trade-off in radar system design; range versus resolution. As average transmitted power, and thus range, is increased by widening the pulse width, the resolution, the ability to detect targets which are close together, suffers. This situation exists in every radar system. Aircraft were used in Figure 2, but this would hold true regardless of the transceiver platform, (satellite, ground based, ship-borne, or hand-held) or the target (clouds, rain, missiles, or underground pipes).

The solution to this problem is what is known as pulse compression. Pulse compression is employed in most every radar system around the world regardless of type and location. The fundamental concept of pulse compression is that rather than simply transmitting a burst CW (unmodulated) signal, one of two parameters are changed over time. Either the phase, shown on the left side of Figure 3, or the frequency, shown on the right side of Figure 3, is changed.

In the case of phase modulation, the phase can be varied either between two states which are 180 degrees apart, known as Binary Phase Shift Keying or BPSK, or varied by a number of phase states, known as poly-phase. QPSK is one example of a poly-phase signal.

- ↓ RF frequency of the pulse continuously changes over the pulse duration in a linear sweep

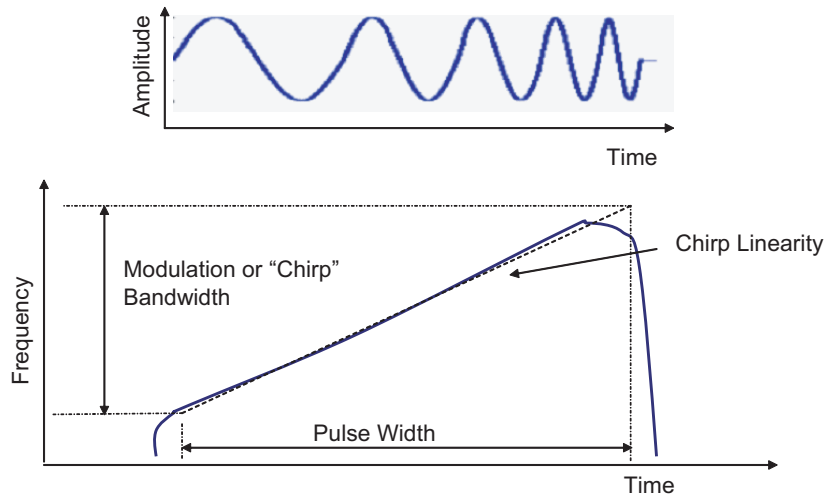

▶ **Figure 4.** Illustration of a linear FM modulated signal where the RF frequency of the pulse continuously changes over the pulse duration.

```

clock = 10e9;      // AWG clock
fc = 1.25e9;      // Center frequency

pd = 4e-6;        // sweep period
fs = -4.5e6;      // starting frequency
fe = 4.5e6;       // ending frequency

len = pd * clock;
t = [0:len-1]/clock;

i = cos(2*pi*fs*t + 2*pi*(fe-fs)*(t^2)/2/pd);
q = sin(2*pi*fs*t + 2*pi*(fe-fs)*(t^2)/2/pd);

t = [0:len-1]/clock;
wfm = i .* cos(2*pi*fc*t) - q .* sin(2*pi*fc*t);
    
```

▶ **Figure 5.** Sample MATLAB® to generate a linear FM modulated signal.

Linear FM, as illustrated in Figure 4, is one of the most common forms of pulse compression. Let's examine what happens when these types of modulated pulses are processed by the receiver.

Such a signal could be generated using an arbitrary waveform generator (AWG) with the code shown in Figure 5.

# Generating Advanced Radar Signals Using Arbitrary Waveform Generators

## ► Application Note

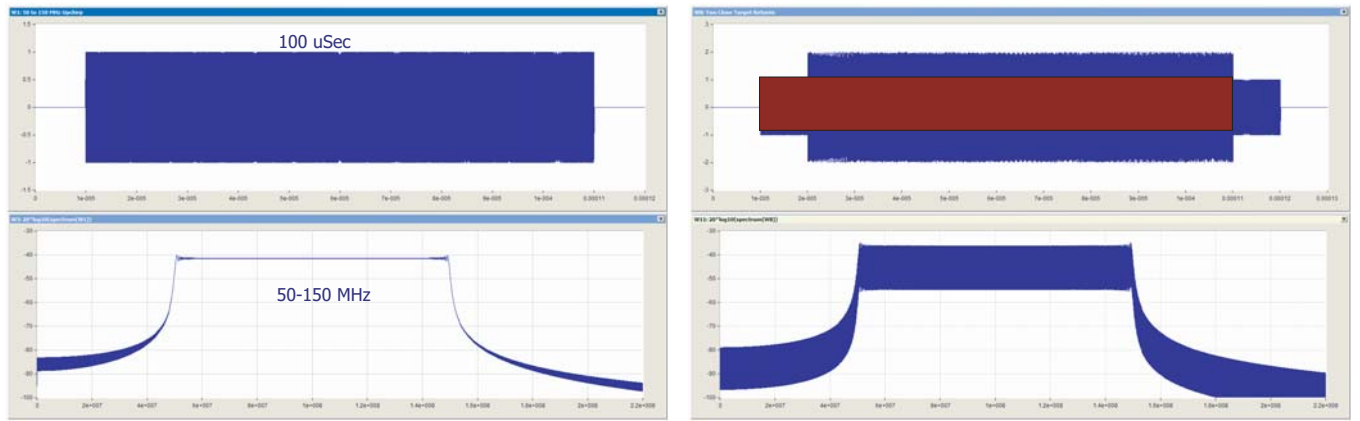

► **Figure 6.** Transmitted LFM signal (left) versus returned signal with 2 targets (right); the brown area in the time domain view is where the target returns overlap.

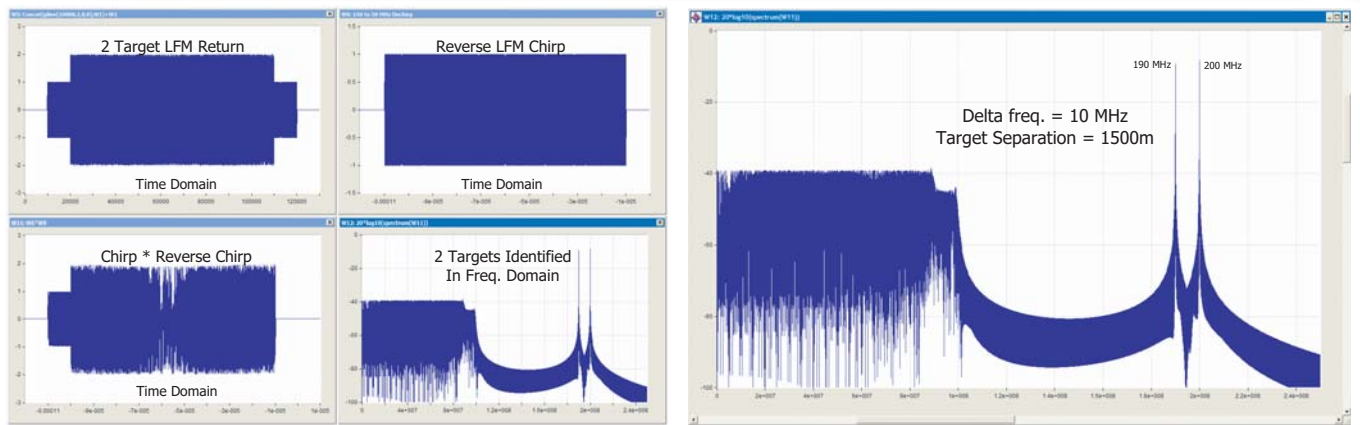

► **Figure 7.** Results of an FFT on the chirp\*reverse chirp product.

In Figure 6, an FFT is performed both on the 100usec LFM transmitted pulse and on the returned signal, which has some overlapping target returns in the time domain. This translates to a broader spectrum with more power spectral density but tells us nothing about the number of targets or their distance from one another. One of the techniques used to decode linear FM is called “stretch-radar” decoding. In this approach the returned signal is

mixed with a reverse LFM signal and then an FFT is performed to convert the different returns into the frequency domain. Returns at different points in time (due to separation in distance) will be seen as separate frequencies. This is illustrated in Figure 7.

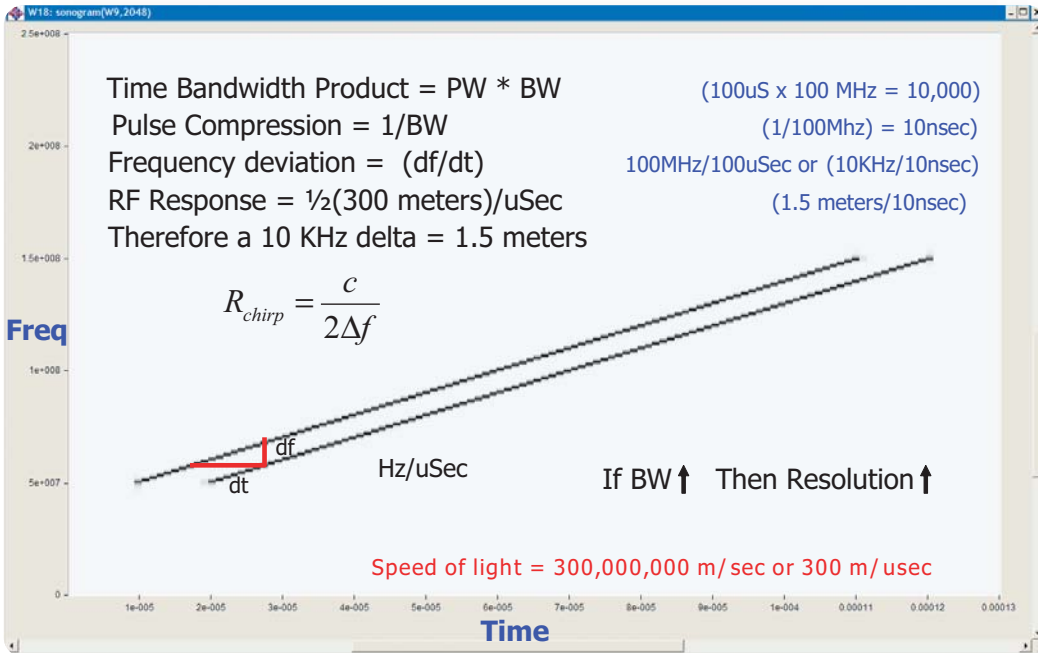

► **Figure 8.** Spectrogram of two target returns from a LFM pulse signal.

One benefit of the AWG offering two analog output channels is that this processing could be performed by simply having the AWG transmit a LFM signal from channel 1, while simultaneously transmitting the reverse LFM from channel 2 into the receiver or channel 2 of an oscilloscope, which mixes with the return signal (or is multiplied by using waveform math) before performing an FFT on the result.

There are also a number of benefits to using an AWG with a high sample rate and wide bandwidth when developing LFM signals. These will be covered later in this application note when covering stretch radar processing.

In the example in Figure 8, a 100us pulse is transmitted with 100MHz change in the transmitter frequency over the pulse duration. This is also known as modulation, or ‘chirp’, bandwidth. The first important factor to calculate is called the “time-bandwidth product” and is found by multiplying the pulse width and bandwidth, which in this case equals 10,000. This tells us that after pulse compression has been performed, we will have a 10,000:1 ratio of uncompressed to compressed pulse.

The 100us transmitted pulse will offer the resolution of a 10nsec pulse. This can be confirmed by calculating the pulse compression, which is the inverse of the BW = 10nsec.

Next we calculate the rate of change (df/dt), which is 100MHz/100us or 10kHz/10nsec. We can correlate this to physical distance by knowing that the signal travels at the speed of light and that we are only interested in half of that value. We are seeing the result of the transmit and return time. Bringing everything into relative terms (150m/us = 1.5m/10ns=10 kHz) provides a way of relating the frequency difference measured on the FFT of the Chirp\*Reverse Chirp signal to actual distance.

Bandwidth has a direct effect on the maximum resolution of a LFM as well as on non-linear FM. The minimum resolution can be calculated as shown in Figure 8. For a 100MHz bandwidth (Δf = 100MHz) it is 1.5 meters. This means that targets must be separated by a minimum of 1.5 meters to be accurately measured using this bandwidth. Since the bandwidth product is in the denominator of the equation, we know that increasing its value will also increase the resolution.

Let’s look at the signal range of this example. When the

## Generating Advanced Radar Signals Using Arbitrary Waveform Generators

### ► Application Note

radar transmission is pulsed, the range of the target can be directly determined by measuring the time between the transmission of each pulse and the reception of the echo from the target. The round trip time is divided in half to calculate the time it took the signal to reach the target. This time, multiplied by the speed of light, is the distance to the target (for example  $R=ct/2$ ). A useful rule of thumb is that 10us of round-trip transit time equals 1.5 kilometers of range, assuming there is sufficient transmit power. So the 100us pulse in our example allows for approximately 15 kilometers of range. Widening the pulse width would allow for a longer range, but would also require the extension of the bandwidth. Doubling the pulse width to 200us would require 200MHz of bandwidth, and so on.

The other affect of bandwidth is the uncertainty of the measured range. Equation 2 shows how bandwidth, along with signal-to-noise ratio, has a direct effect on range uncertainty.

For example, if the bandwidth (B) is 200 MHz and the SNR is 10dB, then the range accuracy is 0.167 meters. The measured range is within an accuracy window of ~0.17m.

$$\sigma_R = \frac{c}{2B\sqrt{2SNR}}$$

**Equation 2.** Bandwidth effect on range uncertainty.

Many modern radars use hundreds of Megahertz or even many Gigahertz of bandwidth to allow for greater resolution and range. AWGs offers up to 5.8GHz of analog bandwidth to allow for LFM and other, even more complex, modulated pulses.

Along with the analog bandwidth needed to support wider frequency chirps, is the requirement for higher sample rate and more memory. Nyquist states that the sample rate needs to be a minimum of twice the highest frequency component. In reality, at least four times over-sampling is desired to improve signal quality. With a sample rate of up to 20GS/s, AWGs allow for direct generation of signals up to 5GHz without the use of an up-converter. For example, if a 1GHz frequency chirp is used, the AWG can sample at 10GS/s and create a pulse width of up to 6.4ms (64MS). Sequence memory can also be used to extend this to even longer duration of signals.

There are two fundamental drawbacks to a linear chip. One is that it does not allow for frequency shift of the returned pulse due to Doppler, which creates ranging errors. The other is that it creates time sidelobes, which can create false target returns (or “ghosts”) as well masking true returns.

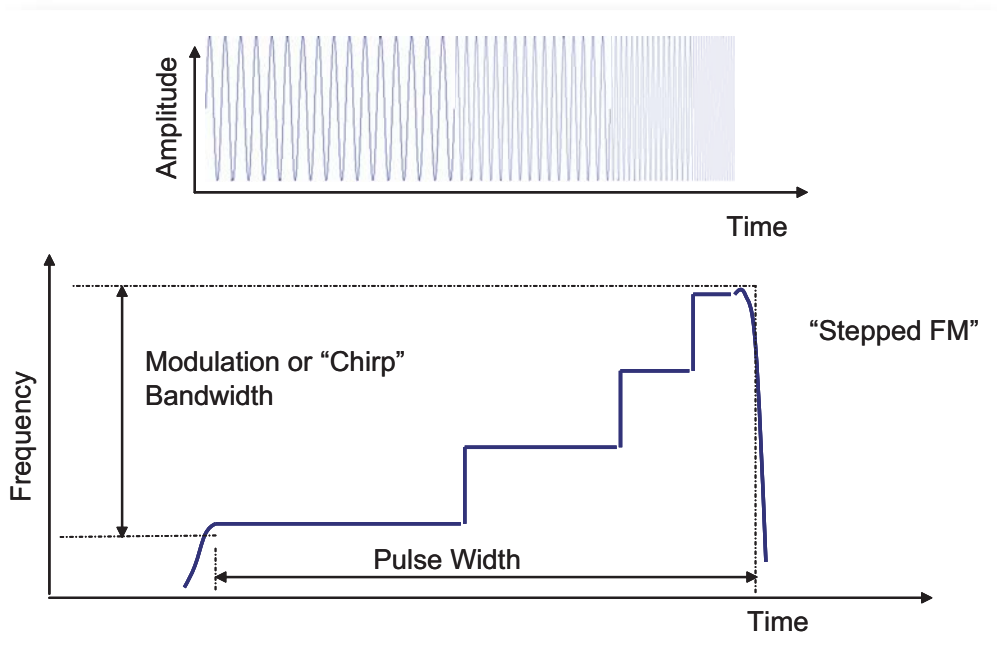

► **Figure 9.** Stepped FM in which a CW component is added to the modulation cycle to allow for Doppler information.

One answer to allow for Doppler accuracy, the rate at which a target is moving toward or away from the transmitter, is to insert a constant frequency segment into the modulation cycle. This creates a 'stepped' frequency change as shown in Figure 9.

The overall accuracy of range in FM modulated pulses depends upon the steepness or rate of the transmitter frequency deviation, or  $df/dt$  as illustrated in Figure 8. The steeper this slope, the more accurately that target range can be determined. Generating steeper slopes with an AWG requires a faster sampling rate and more sample points in order to more precisely generate a highly linear chirp.

The resolution can be improved through the use of wider frequency bandwidth in a given pulse width, as this will increase the Time-Bandwidth product, allowing for greater pulse compression in the receiver. Generating wider frequency bandwidth modulation also requires a faster sample rate and wide analog bandwidth. By offering up to 20GS/s sample rate with 129.6M points of memory and bandwidth of 5.8GHz, the Tektronix AWGs allow for excellent FM modulation signals to be generated, thus improving both range and resolution.

# Generating Advanced Radar Signals Using Arbitrary Waveform Generators

## ► Application Note

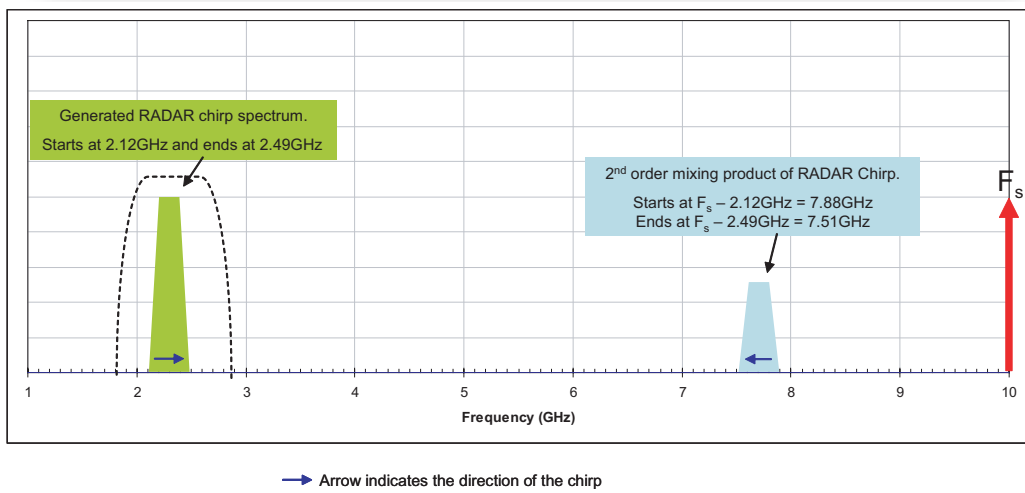
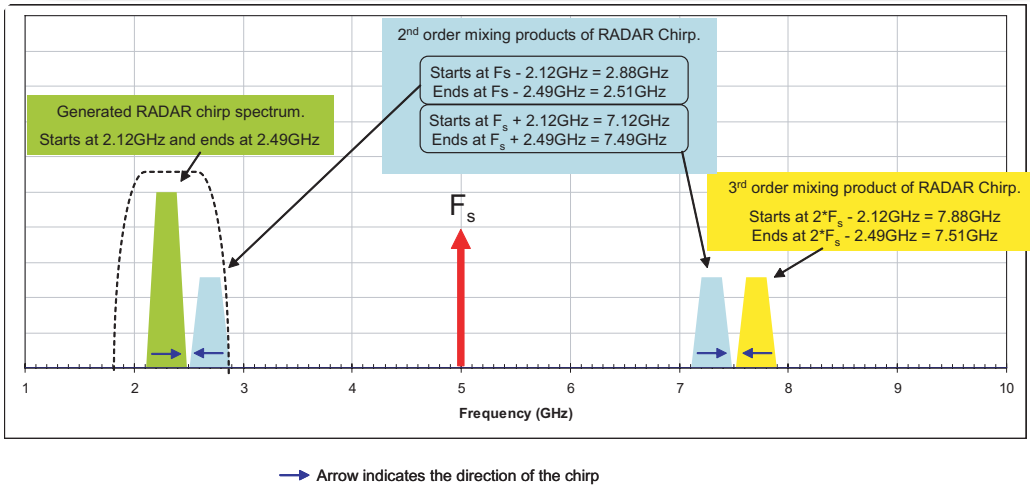

► **Figure 10.** Spectral behavior when generating a LFM 'chirp' at lower sample rate (above) and higher sample rate (below). Note that 5GS/s still meets Nyquist minimum but allows images into the receiver pass-band (shown as a dotted line). Utilizing a 10GS/s sampling frequency moved the 2nd order image away from the receiver passband.

## Reducing False Returns and Increasing Probability of Detection

Recall from Equation 2 that the Signal-to-Noise ratio affects the uncertainty of the range measurement. Low SNR can also cause false returns and allow real targets to go undetected. The average transmitted power can be increased through use of wider pulses, increasing PRI, or increasing the peak power. The range equation shows that increasing the power of the transmitter by a given factor increases the detection range by only about the fourth root of that factor. Doubling the average transmitted power will only increase the detection range

by about 19 percent. At the same time, the equation tells us that decreasing the mean level of the noise by a given factor has the effect of increasing the power by the same factor.

In addition to allowing for wide bandwidth and high direct generation, the high sample rate of the AWGs can be used to improve the signal to noise ratio (SNR). This is due to increasing the spectral placement of spurs such that they do not enter the receiver passband and by decreasing average noise. Let's look in more detail at how that is accomplished.

As shown in the Figure 10, one clear advantage to over-sampling is moving the image/mixing products far outside the receiver passband. For an output signal at

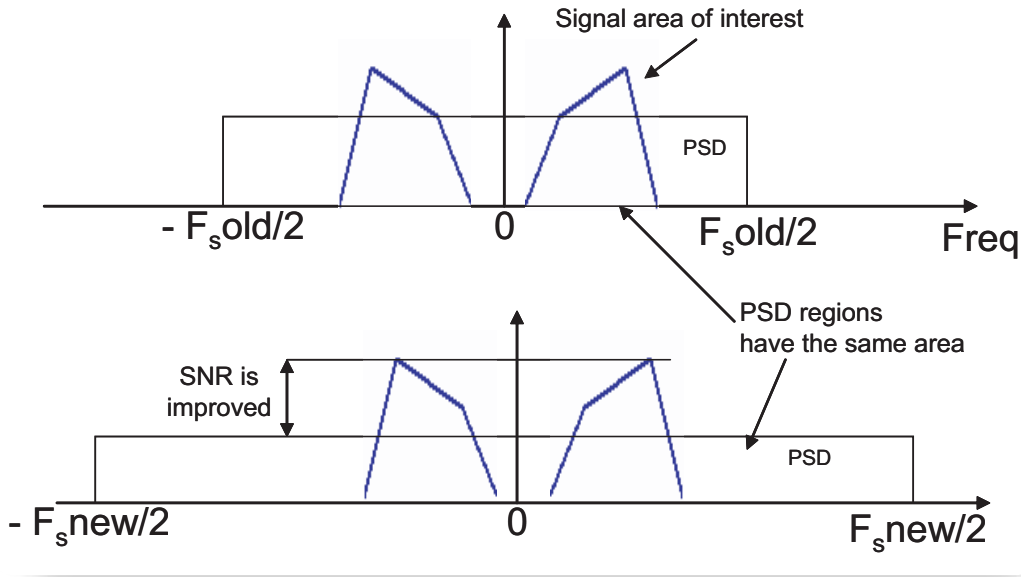

► **Figure 11.**  $PSD_{noise} = [(LSB\ value)^2/12](1/fs) = (LSB\ value)^2/12fs$ .

frequency  $F_{out}$  synthesized with a DAC updated at  $F_{clock}$ , images appear at  $N \cdot F_{clock} \pm F_{out}$ . The amplitude of these images rolls off with increasing frequency according to Equation 3, leaving “nulls” of very weak image energy around the integer multiples of the clock frequency.

$$\frac{\sin \pi(F_{out} / F_{clock})}{\pi(F_{out} / F_{clock})}$$

**Equation 3.** Amplitude of images vary according to this equation.

Another advantage of the high sample rate of AWGs is over-sampling to reduce quantization noise. Over-sampling by a factor of 4, along with filtering, reduces the quantization noise by 1 bit (~6dB). Consequently, it is possible to achieve N+1-bit performance from an N-bit ADC, because signal amplitude resolution is gained when utilizing higher sampling speed. Figure 11 shows reducing Power Spectral Density (PSD) of the noise floor by spreading it across a wider spectral region. AWGs offer 10 bit vertical resolution, which we have seen can be enhanced through the use of higher sampling to remove the effects of imaging products and reduce quantization noise.

# Generating Advanced Radar Signals Using Arbitrary Waveform Generators

► Application Note

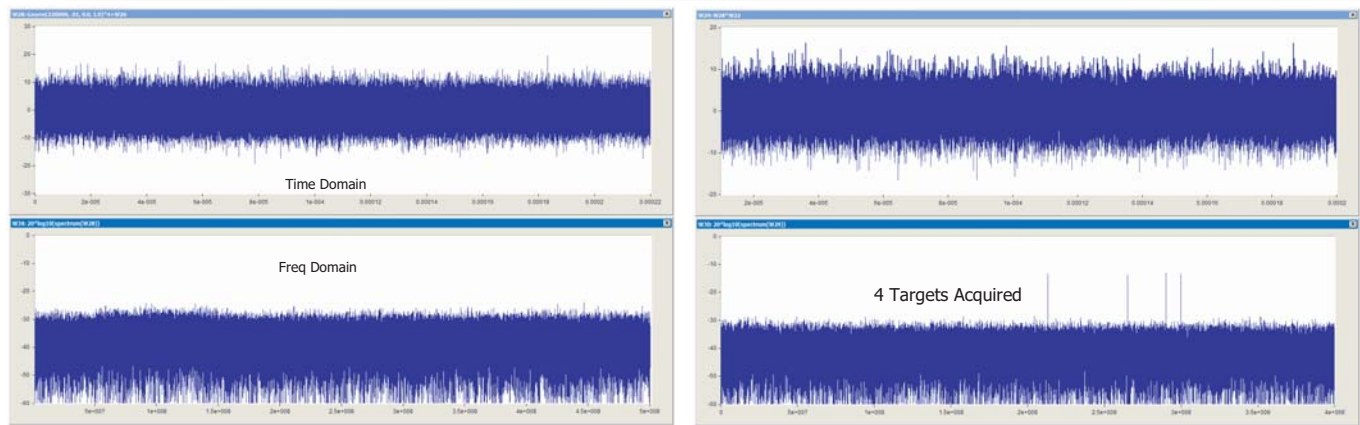

► **Figure 12.** Unknown targets hidden in noise (left). Compressing the power that was previously spread across a wider bandwidth so the signals (target returns) come out of the noise floor (right).



## Conventional Frequency Chirp

## Optimized Frequency Chirp

► **Figure 13.** Use of windowing function to optimize frequency chirped pulses.

The matched filter will enhance the SNR, and as a result is able to detect chirp signals even when they are "buried" beneath the noise level.

Remote sensing systems, such as Synthetic Aperture Radar (SAR), usually apply FM signals to resolve nearly placed targets (objects) and improve SNR as shown in Figure 12.

As mentioned previously, one of the main drawbacks in the use of FM compression is that it can add range sidelobes in reflectivity measurements. Using weighting window processing in the time domain, it is possible to significantly decrease the sidelobe level (SLL) of output radar signals.

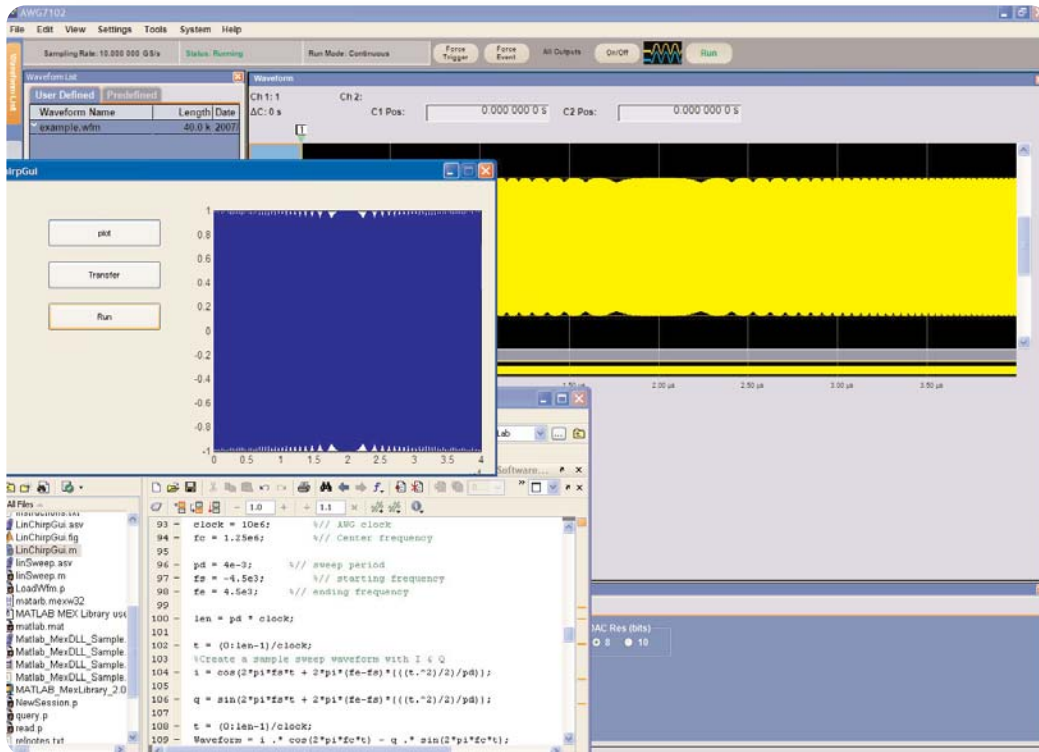

▶ **Figure 14.** Using MATLAB®, integration library to transfer a filtered chirp directly to the AWG.

Window processing typically uses common windows such as Hamming, Hanning, Blackman-Harris, Kaiser-Bessel, Dolph-Chebyshev or Gauss. These windows and filters can be created in MATLAB® and transferred to the AWG using a MATLAB® utility available for download from [www.tektronix.com](http://www.tektronix.com).

### Why not just use an FPGA test bench

Field programmable gate arrays (FPGAs) have wider potential than application-specific integrated circuits (ASICs) because they can be programmed in the field even after customer installation, allowing for future upgrades and enhancements. Typically, DSP designers are unfamiliar with FPGA design tools, and FPGA designers are unfamiliar with DSP algorithms. Building

an FPGA test bench can be a time consuming exercise. Not only do all the components (power supplies, clock source, data converters, memory, etc.) need to be sourced, purchased, and assembled, but then the system must be fully characterized.

A user interface also needs to be written to allow for data transfer and parameter control. Use of an AWG allows for “known good” hardware and an existing GUI to be used so that the focus can be on algorithm development and transceiver chain optimization and troubleshooting. Once the DSP algorithms have been developed, they can be integrated into an FPGA implementation if desired.

### Troubleshooting the Radar Transceiver Chain

# Generating Advanced Radar Signals Using Arbitrary Waveform Generators

► Application Note

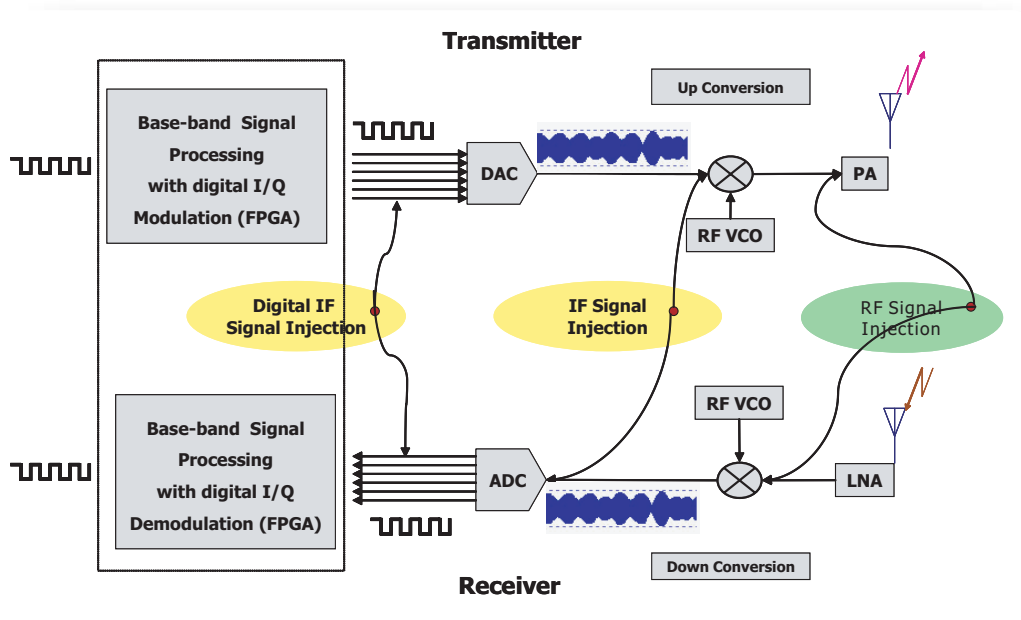

► Figure 15. Signal injection at various stages of the digital transceiver chain.

More and more, modern radar systems are being implemented as digital (or software) defined radios. This is driving the need to test the radar transceiver chain at each stage, including digital IQ signal injection as seen in Figure 15.

Tektronix AWGs, specifically the AWG5000 Series, offer both analog and digital outputs, valuable for transceiver chain testing. The Tektronix AWG7000 Series is ideal for RF and IF signal generation. Both AWG Series offer multiple channel outputs which can be used to test the advanced implementation of antennas known as phased

array which utilize beam-forming techniques.

When using phased antennas, it is important to delay signals at each antenna element by a precise amount so that the array's main lobe can be steered of bore sight. It is important to perform very precise and fast detection and tracking of targets with low reflected energy. This requires phase shifters in the system to produce minimum distortion. The AWG offers the ability to rotate the phase in increments as fine as 0.1 degree to allow for testing the receiver sensitivity to phase changes.

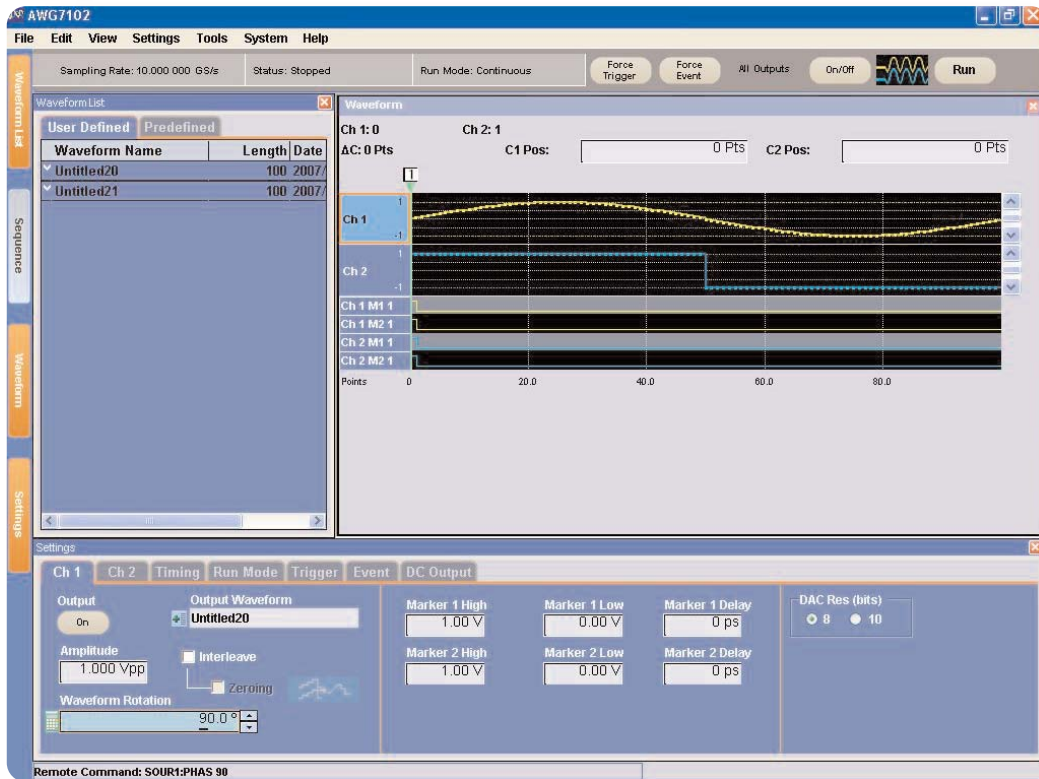

▶ Figure 16. Waveform rotation on the Tektronix Arbitrary Waveform Generator.

## Summary

Generating advanced radar signals often demands exceptional performance from an arbitrary waveform generator (AWG) in terms of sample rate, analog bandwidth, and memory.

The Tektronix AWG7000 Series sets a new industry standard for advanced radar signal generation, by delivering an exceptional combination of high sample rate, wide analog bandwidth, and deep memory. With a sample rate of up to 20Gs/s and 5.8GHz analog bandwidth, the AWG7000 Series can directly generate RF signals never before possible from an AWG. In instances where IQ generation is desired, the AWG7000 offers the ability to over-sample the signal, thereby improving signal quality. An internal, variable clock is utilized, thereby eliminating the cost and complexity of using an external clock source.

Advanced radar systems are also becoming more software defined, whereby more functionality is being handled in the digital baseband domain. Tektronix' AWG5000 Series offers 28 digital signal outputs as well as up to four analog outputs with 14 bits of vertical resolution for challenging dynamic range requirements. This combination allows for signal generation in a truly "mixed signal" environment.

## References and Acknowledgments:

Tektronix application note: "How to Create Direct Synthesis Signals Using Arbitrary Waveform Generators", available at [www.tektronix.com/signal\\_generators](http://www.tektronix.com/signal_generators).

The author wishes to thank the following organization for their contribution to this document: - X-COM Systems, a Tektronix value added reseller (VAR).

## Contact Tektronix:

ASEAN / Australasia (65) 6356 3900  
Austria +41 52 675 3777  
Balkan, Israel, South Africa and other ISE Countries +41 52 675 3777  
Belgium 07 81 60166  
Brazil & South America (11) 40669400  
Canada 1 (800) 661-5625  
Central East Europe, Ukraine and the Baltics +41 52 675 3777  
Central Europe & Greece +41 52 675 3777  
Denmark +45 80 88 1401  
Finland +41 52 675 3777  
France +33 (0) 1 69 86 81 81  
Germany +49 (221) 94 77 400  
Hong Kong (852) 2585-6688  
India (91) 80-22275577  
Italy +39 (02) 25086 1  
Japan 81 (3) 6714-3010  
Luxembourg +44 (0) 1344 392400  
Mexico, Central America & Caribbean 52 (55) 5424700  
Middle East, Asia and North Africa +41 52 675 3777  
The Netherlands 090 02 021797  
Norway 800 16098  
People's Republic of China 86 (10) 6235 1230  
Poland +41 52 675 3777  
Portugal 80 08 12370  
Republic of Korea 82 (2) 528-5299  
Russia & CIS +7 (495) 7484900  
South Africa +27 11 254 8360  
Spain (+34) 901 988 054  
Sweden 020 08 80371  
Switzerland +41 52 675 3777  
Taiwan 886 (2) 2722-9622  
United Kingdom & Eire +44 (0) 1344 392400  
USA 1 (800) 426-2200

For other areas contact Tektronix, Inc. at: 1 (503) 627-7111  
Updated 15 September 2006

Our most up-to-date product information is available at: [www.tektronix.com](http://www.tektronix.com)



Copyright © 2007, Tektronix. All rights reserved. Tektronix products are covered by U.S. and foreign patents, issued and pending. Information in this publication supersedes that in all previously published material. Specification and price change privileges reserved. TEKTRONIX and TEK are registered trademarks of Tektronix, Inc. All other trade names referenced are the service marks, trademarks or registered trademarks of their respective companies.

3/07 FLG/WOW

76W-20730-0

**Tektronix**  
Enabling Innovation



AFC Ingenieros S.A.  
Paseo Imperial, 6, 2ºD  
28005 Madrid  
Contacto: Juan Ojeda  
Directo: 91 7104883  
Móvil: 629160579  
Oficina: 91 3654405  
Email: [jojeda@afc-ingenieros.com](mailto:jojeda@afc-ingenieros.com)