

Time-Correlated Multi-domain RF Analysis with the MSO70000 Series Oscilloscope and SignalVu™ Software

Technical Brief

Introduction

The MSO70000 Series Mixed Oscilloscope, when coupled with SignalVu™ Spectrum Analysis Software, becomes an integrated high performance analysis tool to handle the most advanced RF and microwave transmitter design challenges. This pair provides industry-leading bandwidth of up to 20 GHz and the industry's highest waveform capture rate, best signal fidelity, lowest noise floor and the only available hardware-based serial pattern trigger for data rates up to 5 Gb/s. The MSO70000 also includes 16 logic channels with an 80 picosecond timing accuracy.

The SignalVu Spectrum Analysis software, available on the MSO70000 Series products, can easily validate wideband RF and microwave designs and characterize wideband spectral events. By combining the signal analysis engine of the real-time spectrum analyzer with that of the industry's widest bandwidth mixed signal digital oscilloscopes, you can now evaluate complex signals up to 20 GHz or 40 GHz Baseband IQ, without the need of an external down converter or multiple logic analysis instruments.

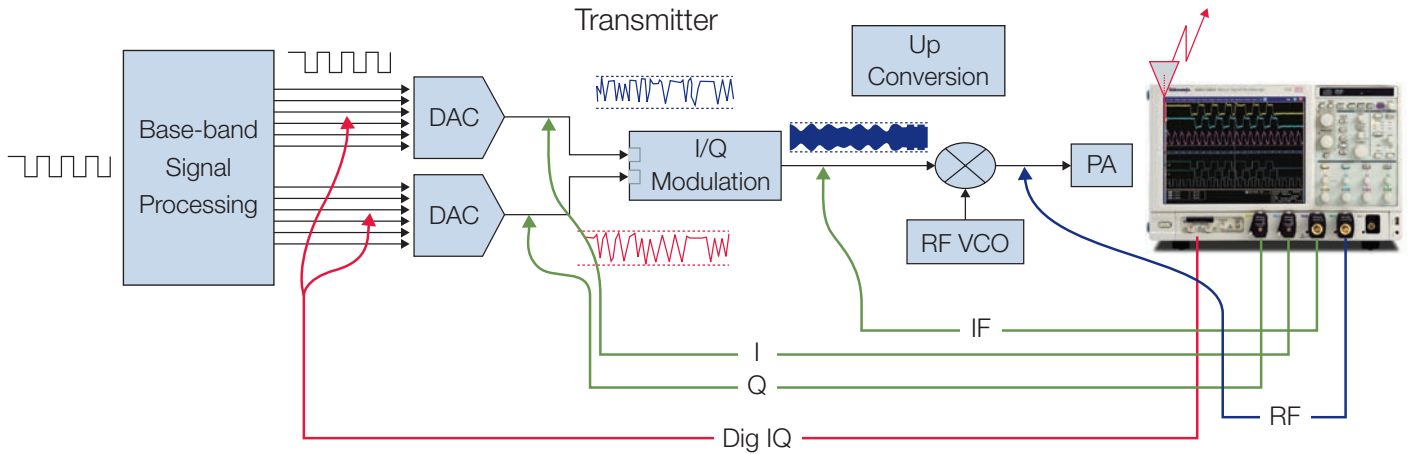

Figure 1. MSO70000 provides connectivity for multi-domain analysis across digital and analog IQ, IF, RF, and microwave signals.

Connectivity

The MSO70000 Series oscilloscope has 16 logic channels, and full integration of RF measurements in all four channels. This allows you to time-correlate and troubleshoot transmitter designs across digital IQ and logic states in baseband, single-

ended or differential IQ analog channels, and directly at IF and RF/microwave frequencies with the same instrument and same acquisition data. Figure 1 shows the versatility to connect the MSO70000 to access points available in a common transmitter architecture.

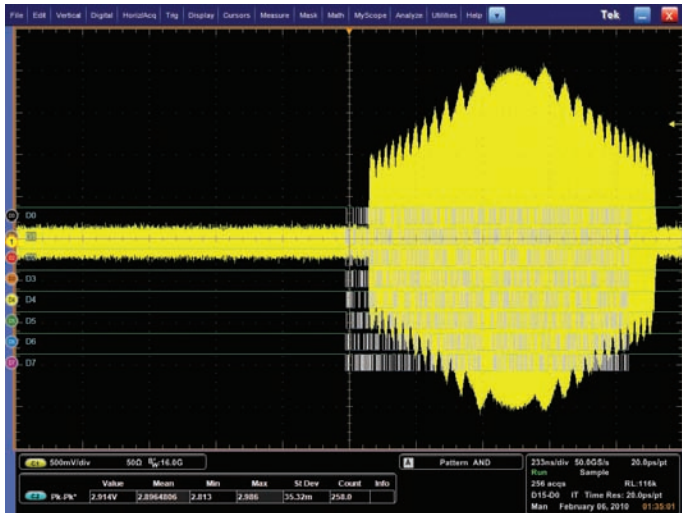

Figure 2. View of the Logic State triggers of a pulsed waveform driving a DAC and the RF signal in traditional mixed signal oscilloscope view.

Multi-domain Measurements

The integration of the logic state triggers enables a time-correlated acquisition from the digital domain to the analog domain with a timing accuracy of 80 picoseconds. For the example waveforms captured in Figure 2, several logic state triggers were probed on the digital channels of a dual high-speed digital-to-analog converter (DAC) configured to generate an IQ analog signal. The dual DAC's were then feed to an IQ modulator, wideband upconverter, filtered, and captured with an analog channel of the same oscilloscope. This configuration utilized only several of the 20 channels available (16 logic states, and 4 analog inputs).

A pattern trigger was set to monitor the logic states driving the DAC. This triggered an acquisition of an incoming pulse signal feeding the transmitter. The analog channel shows the absolute delay of the transmitter chain between the logic channels and the RF signal to be less than 100 ns (with a timing resolution accuracy of less than 0.1%).

Since the SignalVu Spectrum Analysis software is integrated into the acquisition engine of Tektronix 70000 Series oscilloscopes, you now have the ability to combine the flexibility of the timing and logic state triggers of the oscilloscope with a high performance RF analysis tool for multi-domain analysis. Further, you now have the timing resolutions and accuracies available in the highest performance oscilloscopes.

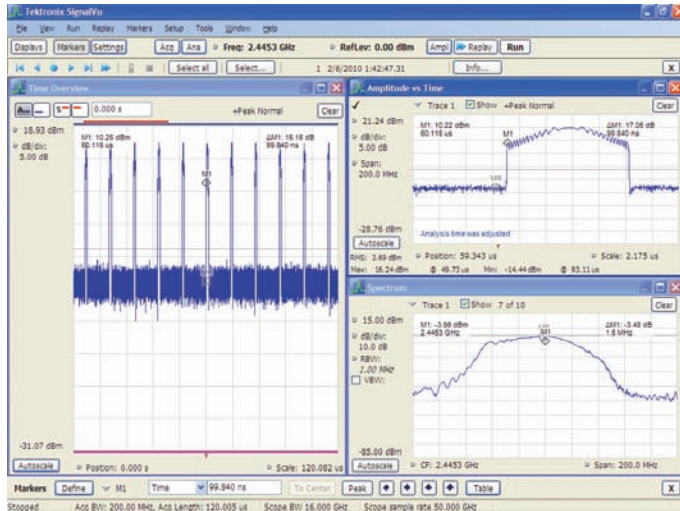

Figure 3. The acquisition trigger from the previous example has been set to the marker reference point enabling time-correlated RF measurements between logic state and RF.

Figure 3 shows the representative acquisition triggered by the same logic pattern driving the DAC and a longer acquisition of a pulse train that has been captured for further analysis. Using the correlated markers between windows in the SignalVu software, the marker reference has been assigned to the logic trigger (represented by the small “T” at the bottom of the horizontal bar in the Amplitude vs. Time display, upper right).

A measurement marker is now placed on the peak of the rising edge of the pulse signal. The delta marker measurement shows the delay from the digital signal driving the DAC to the RF pulse measurement is 99.84 ns. This is the combination of all group delays across the entire transmitter demonstrated with a single time-domain acquisition.

The analysis flexibility of the SignalVu software provides over 27 automated measurements for scalar and vector pulse analysis and over dozens of analysis windows for common RF measurements. Including over 30 types of modulation analysis formats.

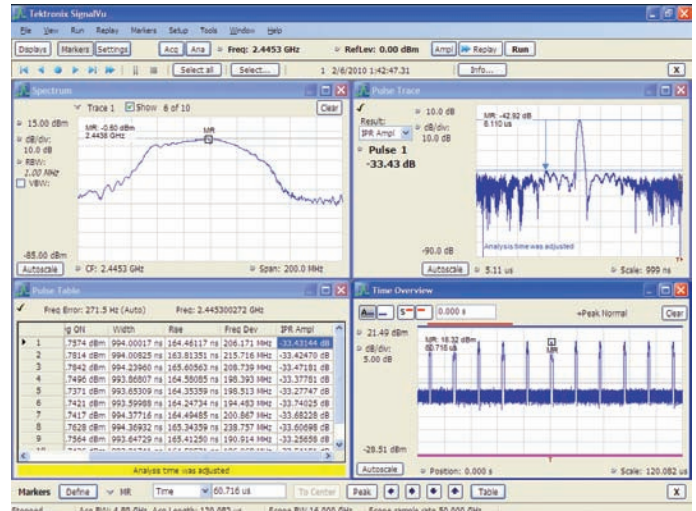

Figure 4. Once acquired, data can be analyzed with the flexibility of a high performance vector signal analyzer.

For pulse analysis, the Impulse Response measurement, or time-sidelobe, is a key parametric assessment measurement of the pulse quality of the transmitter. The impulse response is able to graphically display the time and amplitude imperfections and non-linearities within the transmitter and the response to chirp waveforms. This could include triple returns due to mismatch error, AM or FM coupling, or other aberrations impacting the pulse quality of the signal.

In Figure 4, the pulse table has been selected to perform automated analysis of the acquired signal. The spectrum, time-overview, pulse statistics, and impulse response of a specific pulse are shown to demonstrate the flexibility in analysis.

For all these RF analysis, remember that the correlated logic patterns are also being acquired to enable a thorough evaluation of the logic states within the transmitter based on the RF performance measured in the SignalVu software.

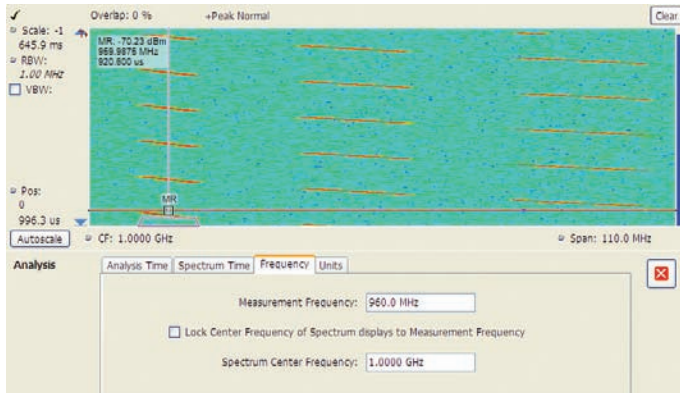

Figure 5. Off-center frequency analysis.

Flexible RF Analysis

When designing frequency hopping radios or radars, traditional RF analysis tools require the signal of analysis to be located in the center of the RF analysis window. To perform this, one has to either be lucky enough to capture the signal-of-interest when it occurs exactly in the analysis window or a special (non-hopping) test mode needs to be implemented to guarantee a signal is captured.

Often the most difficult behaviors to troubleshoot occur when hopping systems are actually hopping. Discovering timing and settling issues are not fully vetted with static non-hopping test modes.

The SignalVu spectrum analysis software allows you to decouple the measurement window of interest across the entire span of the captured signal. Figure 5 shows the control using the Spectrogram display, enabling the measurement analysis window to be placed only at one particular hopping frequency of a hopping radar signal. The hopping analysis window can be placed anywhere within the 20 GHz span of interest in the MSO70000 Series oscilloscopes.

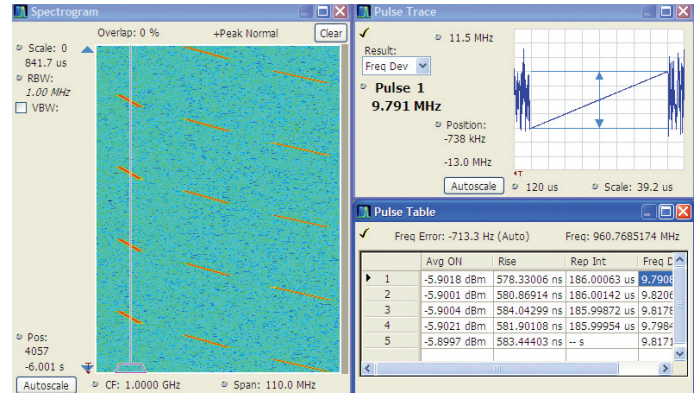

Figure 6. Pulse analysis is performed just on the window at the selected frequencies.

By selecting on off-center signal of interest, you can demodulate radio signals or perform pulse analysis on just the signals that occur within the spectrum window during the acquisition. Utilizing complex triggered or segmented memory, can efficiently enhance the observation period for the selected frequency.

Figure 6 shows a selected spectrum of a frequency hopping chirp radar. The measurement window is selected just on the right most chirp pulse signal. The subsequent analysis of automatic pulse statistics and chirp pulse frequency deviation are performed just on the selected of pulses, ignoring all other signals in the acquisition.

With the SignalVu software, once you have acquired a signal, you may replay the data from memory with subsequent refinement of you measurement window to analyze other signals that might have been captured within memory.

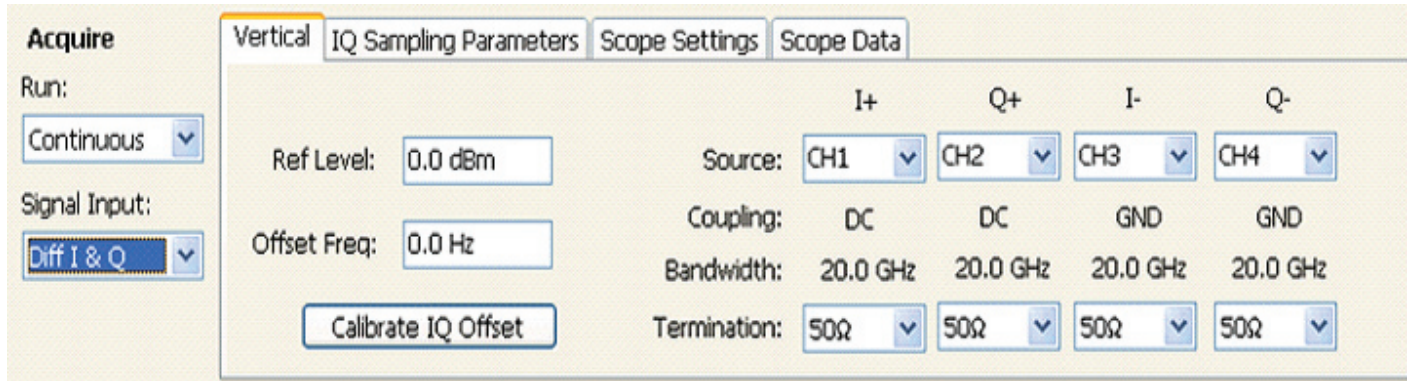

Figure 7. Acquisition setup control includes controls for each channel, offset frequency, and single button IQ offset calibration.

Flexible Analog Baseband Analysis

The MSO70000 Series Mixed Signal oscilloscope and the SignalVu software can combine to give the most flexibility in analysis of baseband analog signals. This includes:

- Analog IQ bandwidths to 40 GHz.
- Differential IQ measurements.
- Single button calibration for DC offsets and imbalance.
- Support of Zero-IF and Near Zero-IF analysis.

With real-time bandwidths available on 'I' and 'Q' channels each for 20 GHz, this combines for a baseband analysis of 40 GHz. Differential IQ analysis requires acquisition across all 4 analog channels of an oscilloscope. The full acquisition bandwidth is available across all for channels making this combination of differential IQ analysis to 40 GHz unique in the industry.

In addition to the support of Zero-IF and Near-Zero IF architectures, with the ability to select an Offset Frequency analysis, the unique calibration routine in the SignalVu software automatically corrects distortions from IQ imbalance (represented by negative frequency image products) and DC components caused by IQ offset.

Summary

With the MSO70000 and SignalVu software, you get the functionality of a vector signal analyzer, a spectrum analyzer, and the powerful trigger capabilities of a digital oscilloscope (including PinPoint™ Triggering and FastFrame™ Segmented Memory) - all in a single package. Whether your design validation needs include wideband radar, high data rate satellite links, or frequency hopping communications, SignalVu vector signal analysis software can speed your time-to-insight by showing you time variant behavior of these wideband signals.

Contact Tektronix:

ASEAN / Australasia (65) 6356 3900
Austria 00800 2255 4835*
Balkans, Israel, South Africa and other ISE Countries +41 52 675 3777
Belgium 00800 2255 4835*
Brazil +55 (11) 3759 7600
Canada 1 (800) 833-9200
Central East Europe, Ukraine and the Baltics +41 52 675 3777
Central Europe & Greece +41 52 675 3777
Denmark +45 80 88 1401
Finland +41 52 675 3777
France 00800 2255 4835*
Germany 00800 2255 4835*
Hong Kong 400-820-5835
India (91) 80-42922600
Italy 00800 2255 4835*
Japan 81 (3) 6714-3010
Luxembourg +41 52 675 3777
Mexico, Central/South America & Caribbean 52 (55) 53 35 10 85
Middle East, Asia and North Africa +41 52 675 3777
The Netherlands 00800 2255 4835*
Norway 800 16098
People's Republic of China 400-820-5835
Poland +41 52 675 3777
Portugal 80 08 12370
Republic of Korea 82 (2) 6917-5000
Russia & CIS +7 (495) 7484900
South Africa +27 11 206 8360
Spain 00800 2255 4835*
Sweden 00800 2255 4835*
Switzerland 00800 2255 4835*
Taiwan 886 (2) 2722-9622
United Kingdom & Ireland 00800 2255 4835*
USA 1 (800) 833-9200

* European toll-free number. If not accessible, call: +41 52 675 3777

Contact List Updated 09 December 2009

For Further Information

Tektronix maintains a comprehensive, constantly expanding collection of application notes, technical briefs and other resources to help engineers working on the cutting edge of technology. Please visit www.tektronix.com



Copyright © 2010, Tektronix. All rights reserved. Tektronix products are covered by U.S. and foreign patents, issued and pending. Information in this publication supersedes that in all previously published material. Specification and price change privileges reserved. TEKTRONIX and TEK are registered trademarks of Tektronix, Inc. All other trade names referenced are the service marks, trademarks or registered trademarks of their respective companies.

04/10 EA/FCA
TEK6398

37W-24976-0

Tektronix



Paseo Imperial, 6 - 28005 Madrid
Tel.: 91 3654405 - Fax: 91 3654404
Email: afc@afc-ingenieros.com
Web: www.afc-ingenieros.com